

9225 92x92x25mm



General Specifications

- ◆ Material..... Frame: Die-Casting aluminum painted black, Impeller: PBT (UL94V-0)
- ◆ Motor Shaded pole
- ◆ Protection..... Impedance protection or thermal protection
- ◆ Dielectric Strength..... 50/60Hz 1500VAC 1min (Between input terminal and frame)
- ◆ Temperature Range.... Operating temperature ball bearing -40°C~70°C (Non-condensing)
Sleeve bearing -20°C~70°C (Non-condensing)
- ◆ Expected Life..... Ball bearing 50,000hrs at 40°C , Sleeve bearing 30000hrs at 40°C
- ◆ Safety Approval..... CE

Specifications

Model	Rev	Rated Voltage	Freq	Input Current	Input Power	Speed	Max Air Flow		Max Static Pressure		Noise	Weight	Curve
Part No.	XXX	VAC	Hz	Amp	Watt	RPM	CFM	m ³ /min	Inch-H ₂ O	Pa	dB-A	g	
AA09225B11HL(T)	F01	110	60	0.15	15	2850	31.33	0.89	0.18	43.75	36.2	270.0	1
AA09225S11HL(T)	F01	110	60	0.15	15	2750	30.23	0.86	0.16	40.73	35.8	270.0	2
AA09225B22HL(T)	F01	220	50	0.08	17	2350	25.55	0.72	0.12	30.04	32.4	270.0	3
AA09225S22HL(T)	F01	220	50	0.08	17	2250	24.46	0.69	0.11	27.54	32.1	270.0	4

All models could be customized on voltage or any other requirements to fit your need.

Note: "11" is 110 VAC , "22" is 220 VAC , (L) is Leadwire , (T) is Terminal

Dimensions (Unit:mm)

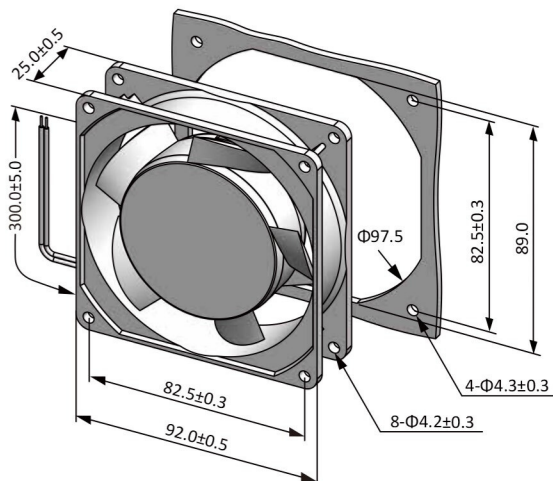

PQ Curve (At Rated Voltage)

